

SONY

3-759-910-21 (1)

Portable
MD DATA Drive **MDH-10**



Operating Instructions

Owner's Record

The model and serial numbers are located at the bottom. Record the serial number in the space provided below.

Refer to these numbers whenever you call upon your Sony dealer regarding this product.

Model No. MDH-10

Serial No. _____

WARNING

To prevent fire or shock hazard, do not expose the unit to rain or moisture.

To avoid electrical shock, do not open the cabinet. Refer servicing to qualified personnel only.

CAUTION

The mains plug on this equipment must be used to disconnect mains power.

Please ensure that the socket outlet is installed near the equipment and shall be easily accessible.

CAUTION

As the laser beam used in the MDH-10 is harmful to the eyes, do not attempt to disassemble the unit. Refer servicing to qualified personnel only.

Information

For the customers in USA

This equipment has been tested and found to comply with the limits for a Class B digital device, pursuant to Part 15 of the FCC Rules. These limits are designed to provide reasonable protection against harmful interference when the equipment is operated in a commercial environment. This equipment generates, uses, and can radiate radio frequency energy and, if not installed and used in accordance with the instructions, may cause harmful interference to radio communications. However, there is no guarantee that interference will not occur in a particular installation. If this equipment does cause harmful interference to radio or television reception, which can be determined by turning the equipment off and on, the user is encouraged to try to correct the interference by one or more of the following measures:

- Reorient or relocate the receiving antenna.
- Increase the separation between the equipment and the receiver.
- Connect the equipment into an outlet on a circuit different from that to which the receiver is connected.
- Consult the dealer or an experienced radio/TV technician for help.

You are cautioned that any changes or modifications not expressly approved in this manual could void your authority to operate this equipment.

The shielded interface cable recommended in this manual must be used with this equipment in order to comply with the limits for a digital device pursuant to Subpart B of Part 15 of FCC Rules.

For the customers in Canada

This apparatus complies with the Class B limits for radio noise emissions set out in Radio Interference Regulations.

Pour les utilisateurs au Canada

Cet appareil est conforme aux normes Classe B pour bruits radioélectriques, spécifiés dans le Règlement sur le brouillage radioélectrique.

**DISPOSAL OF LITHIUM ION
BATTERY.**

**LITHIUM ION BATTERY.
DISPOSE OF PROPERLY.**

You can return your unwanted lithium ion batteries to our nearest Sony Service Center or Factory Service Center.

Note: In some areas the disposal of lithium ion batteries in household or business trash may be prohibited.

For the Sony Service Center nearest you call
1-800-222-SONY (United States only)
For the Sony Factory Service Center nearest you
call 416-499-SONY (Canada only)

Caution: Do not handle damaged or leaking lithium ion battery.

Before Using the Unit

- We are not liable for monetary damage, lost profit or any claim from a third party caused by the use of the supplied software.
- Copyright laws prohibit duplicating the supplied software and operating instructions in whole or in part, and renting the software without the authorization of the rightful party.
- If there should be any manufacturing defects, we will exchange the unit. We are not liable for other reasons.
- Use the supplied software only with the specified unit. We are not liable for damage caused by using the software with unspecified units.
- The specifications of the supplied software are subject to change without notice.

MD DATA is a trademark of Sony Corporation.

Macintosh and PowerBook are trademarks of Apple Computer, Inc. of the U.S.A.

ADAPTEC and ASPI are trademarks of Adaptec, Inc. of the U.S.A.

Future Domain and Power SCSI! are registered trademarks of Future Domain Corp. of the U.S.A.

MS-DOS and Windows are trademarks of Microsoft Corporation of the U.S.A.

Other names of companies and products appearing in this manual are trademarks or registered trademarks of their respective companies.

Table of Contents

Before Using the Unit	4	Introduction
About This Manual	6	
Introduction		
Features	7	
Supplied Accessories	8	
Types of Discs	9	
Recording/Reading Data — Using the Unit as a Portable MD DATA Drive		Recording/Reading Data
Required System	10	
Connection to the Computer	12	
Installing Software	17	
Recording/Reading Data	19	
MD DATA Utilities	22	
Listening to an Audio MD — Using the Unit as a Portable MiniDisc Player		Listening to an Audio MD
Connection	25	
Power Sources	26	
Playing an Audio MD	30	
Playing the Tracks Repeatedly	34	
Useful Tips on Playing an MD	35	
Others		Others
Identification of Parts	37	
Precautions	39	
Troubleshooting	41	
Specifications	46	

About This Manual

This manual explains the operation and handling of the MDH-10 Portable MD DATA Drive. Before operating the unit, please read this manual thoroughly and retain it for future reference.

This manual consists of the following four chapters. Read the corresponding chapters according to your needs.

Introduction

This section explains features, supplied accessories and usable discs.

Recording/Reading Data — Using the Unit as a Portable MD DATA Drive

This section explains the preparations for using the unit connected to a computer, recording/reading data and utilities.

Listening to an Audio MD — Using the Unit as a MiniDisc Player

This section explains the power sources and operations when using the unit as a MiniDisc player and listening to an MD.

Others

This section explains the identification of parts, precautions, troubleshooting and specifications.

Introduction

Features

This unit is a portable MD DATA drive with the MD DATA standard, applying the personal audio "MiniDisc (MD)" technology as a data storage medium for computers.

- The 2.5-inch (64 mm) diameter disc makes this compact size possible. You can carry it in your pocket.
- A large capacity of 140MB makes it possible to store the same amount of data as almost 100 floppy disks on one MD DATA. This capacity of 140MB makes it suitable for storing such data as full-color images for Desk-top Publishing and multimedia applications including sound and video.
- The magneto optical recording system allows repetitive erasing and rewriting.
- The unit is operable on batteries so that you can carry it anywhere, such as to a presentation or on a business trip.
- The use of SCSI-2 (Small Computer System Interface) makes a simple connection of the unit to the computer with one SCSI cable (not supplied), using the supplied device driver and MD DATA File System.
- The highly-reliable error checking and correction function (ECC) makes an error rate of 10^{12} or less possible.
- Using the supplied MD DATA File System, an MD DATA can be commonly used between Macintosh system and PC computers, and the data is interchangeable.
- By switching the mode, the unit can be used either as an MD DATA drive or a MiniDisc player.

Note

The MDH-10 is operable on AC, rechargeable battery, and dry battery power. It is recommended to use the AC power adaptor when connecting the unit to a computer.

Supplied Accessories

After unpacking, please make sure that the unit and the following accessories are included. If there should be any missing item or damage, please contact your Sony sales representative.

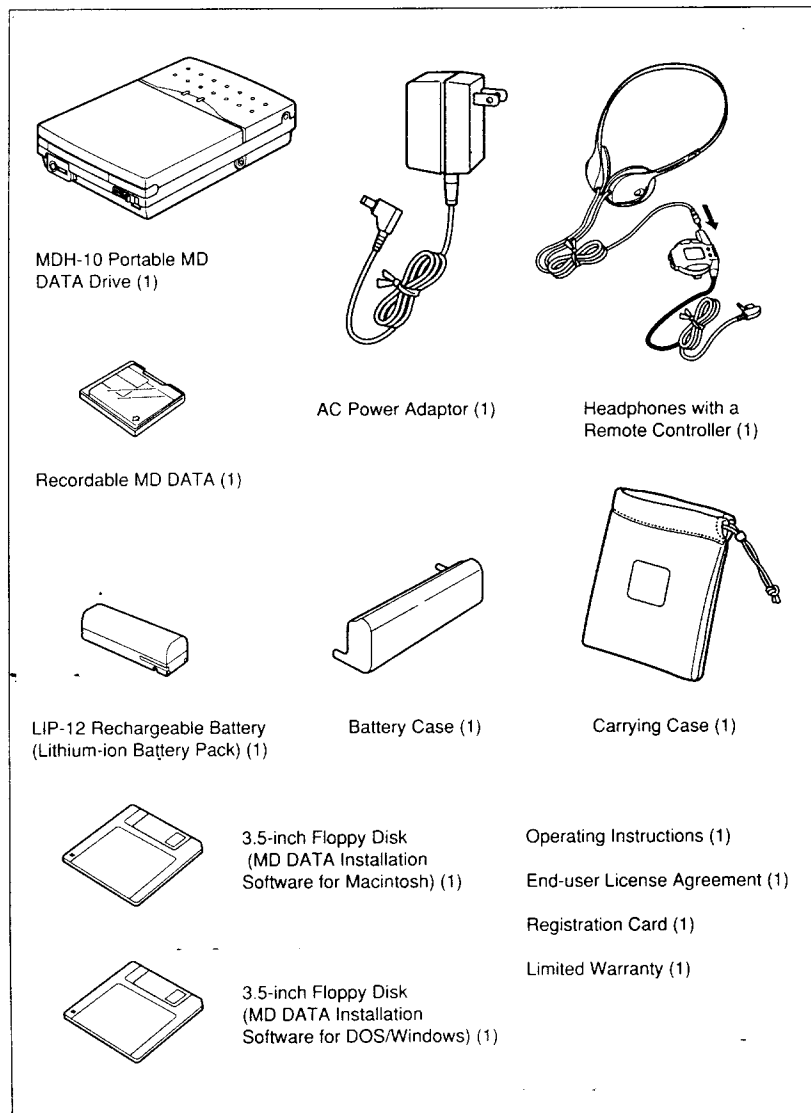

Types of Discs

Two kinds of discs can be used with this unit: MiniDisc (MD) for enjoying music, and MD DATA for handling computer data. MD DATA can be used like conventional floppy disks and CD-ROM. The unit accepts both kinds of discs; however, MD can only be used for playback.

MD DATA

MD DATA is used for handling computer data. There are three types of MD DATA, and they all can be used on the same system for different purposes. Set the POWER/Mode select switch to DATA when using MD DATA.



- **Recordable MD DATA (supplied with this unit)**

This disc is for recording/reading the data.

- **Read-only MD DATA**

This disc is for reading only, like CD-ROM discs.

- **Hybrid MD DATA**

This disc has both a reading only section and a recording/reading section.

MiniDisc (MD)

MiniDisc is for recording and playing back audio data. There are two types of MD: Prerecorded MD for playback only, and Recordable MD for recording/playback. Set the POWER/Mode select switch to AUDIO when using the MD.



- **Prerecorded MD.**

This disc is for audio playback only, like compact discs (CDs).

- **Recordable MD**

This disc is for both recording and playback. This unit can play recorded MiniDiscs. However, you cannot record music and data on the disc with this unit.

Recording/Reading Data

— Using the Unit as a Portable MD DATA Drive

Connect the unit to a computer.

Required System

This unit can be used with the following computers:

- Macintosh (Desk-top type, PowerBook series, Power Macintosh), CPU 68020 and up, System 7.0 and up
- Portable PC with PCMCIA Type II or Type III slot, CPU 386 and up, MS-DOS version 5.0 and up, Windows 3.1
- Desk-top PC, CPU 386 and up, MS-DOS version 5.0 and up, Windows 3.1

Check your computer before you connect the unit to the computer, set the SCSI ID switches and install software.

Computer to be used	Required accessories (not supplied)	Connections	Installation
A Macintosh (Desk-top type, PowerBook series, Power Macintosh)	SCSI cable <ul style="list-style-type: none"> • Half pitch 50-pin ↔ HDI-30 (for PowerBook series) • Half pitch 50-pin ↔ D-sub 25-pin (for desk-top type) 	Page 14	Page 17
B Portable PC with PCMCIA Type II or Type III slot	PCMCIA Interface Kit <ul style="list-style-type: none"> • Sony RMO-K600(E) PCMCIA I/F kit <ul style="list-style-type: none"> - SCSI card - Cable - Device driver (ASPI Manager) 	Page 15	Page 17
C Desk-top PC	SCSI cable <ul style="list-style-type: none"> • Half pitch 50-pin ↔ • Full pitch 50-pin for Adaptec SCSI host adaptor* • Half pitch 50-pin ↔ • D-sub 25-pin for Future Domain SCSI host adaptor* 	Page 16	Page 18

*** Recommended SCSI host adaptors**

This unit uses a SCSI interface. When connecting to one of the above  computers, make sure that the following SCSI host adaptor is correctly installed together with the driver software. If you have a host adaptor which is not listed here, consult the manufacturer of the product for information on compatibility with the MDH-10.

Manufacturer	Model name	Driver software
Adaptec	AHA-154X series	ASPI4DOS.SYS
	AHA-151X series	ASPI2DOS.SYS
Future Domain	TMC-850	Power SCSI!

For installation of the host adaptor, refer to the host adaptor's operation manual.

Connection to the Computer

System structure

You can connect the MDH-10 to a host computer which uses a SCSI host adaptor or card as an interface.

The MDH-10 has only one SCSI connector. When making a daisy chain connection, connect the MDH-10 at the end, and make sure that the terminator switch is set to ON (see below).

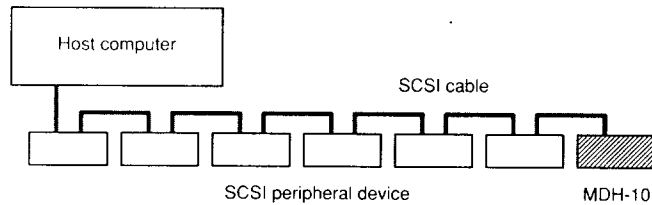

Setting the terminator switch and SCSI ID switches

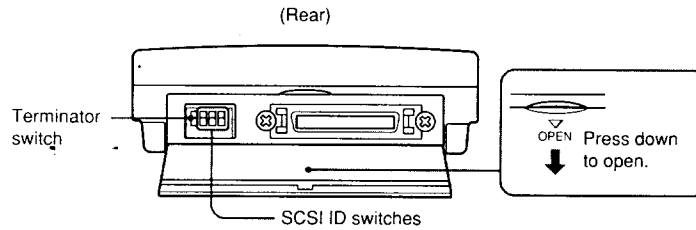

Setting the terminator switch (Switch 1)

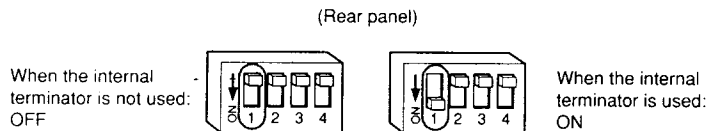

Setting the SCSI ID switches (Switches 2, 3 and 4)

Note: Before changing the settings of SCSI switches, make sure that all the power is disconnected.

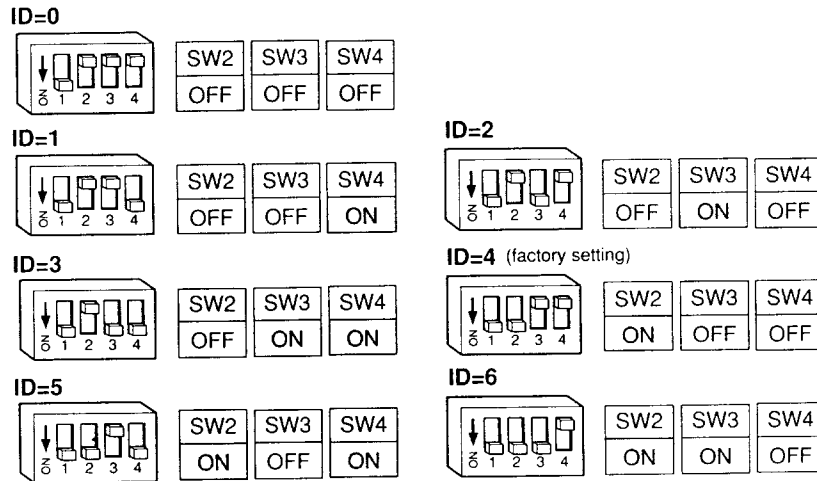

Recording/Reading
Data

Checking the ID numbers

- Setting switch 2 (SW2) to ON means 4.
- Setting switch 3 (SW3) to ON means 2.
- Setting switch 4 (SW4) to ON means 1.

The ID number is the sum of the settings of switches 2, 3 and 4.

The factory setting is ID=4. It is not necessary to change the ID setting unless another SCSI peripheral device is connected with the same ID number. When connecting other SCSI peripheral devices, set to an unused ID. Furthermore, as ID=7 (all switches are ON) is the ID of the computer, avoid the ID=7 setting except in special cases.

Connection to the Computer (Continued)

Before Connecting

- The unit can operate on AC, rechargeable battery, and dry battery power. It is recommended to use AC power when connecting the unit to a computer.
- Before connecting the unit to a computer, make sure that the power is disconnected from both the computer and the drive.

A Connecting to Macintosh

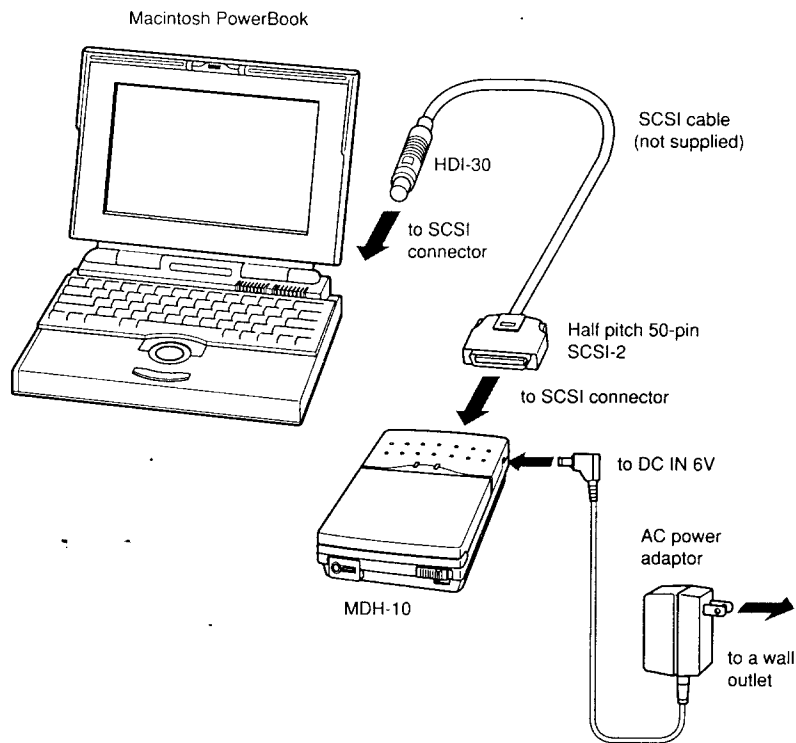

Note

When using Macintosh desk-top machines, use the SCSI cable of half pitch 50-pin to D-sub 25-pin (not supplied).

B Connecting to portable PC with PCMCIA Type II or Type III slot

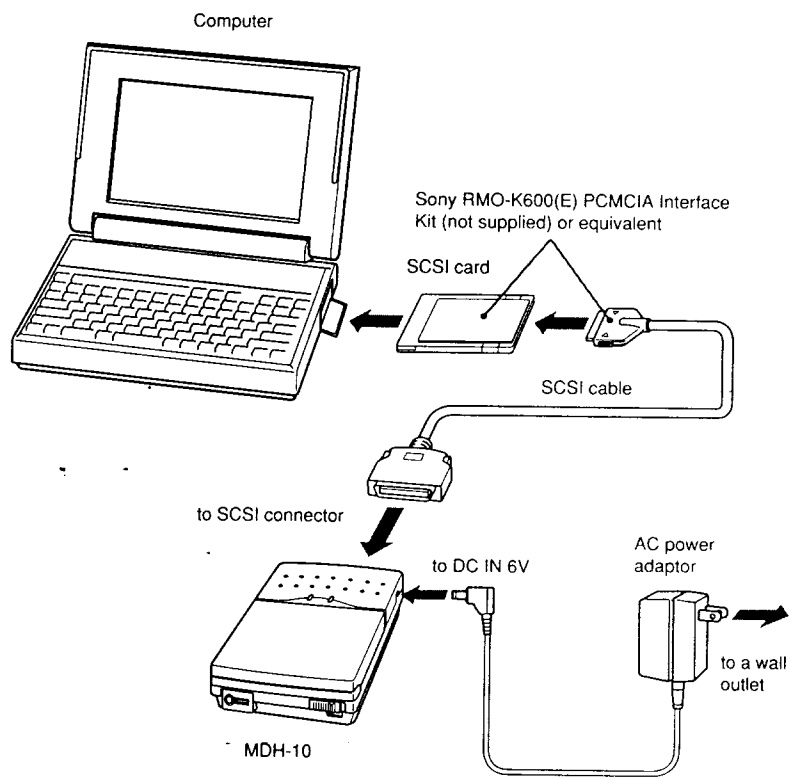

Recording/Reading
Data

Connection to the Computer (Continued)

C Connecting to desk-top PC

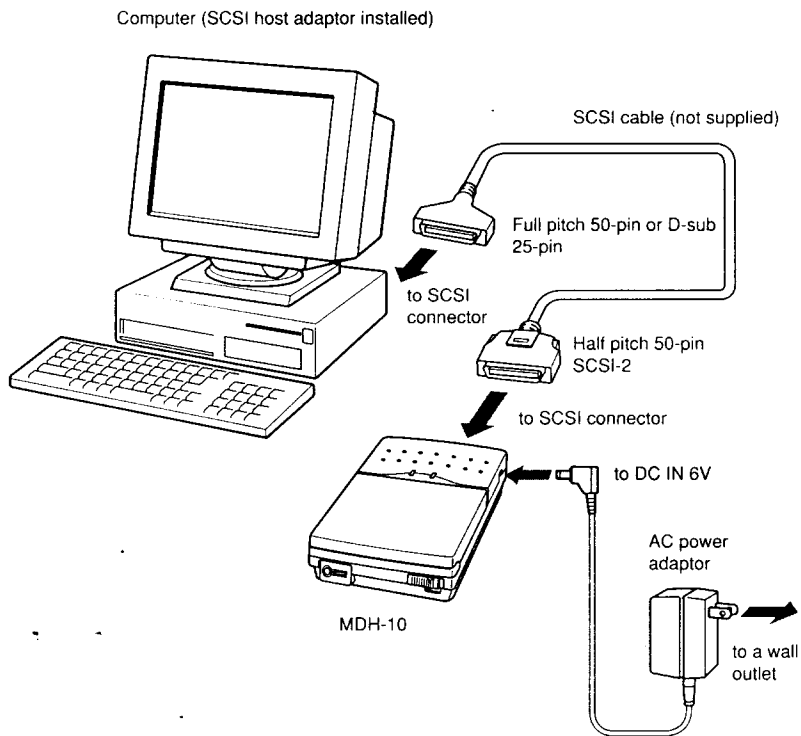

Note

Prepare the SCSI cable according to the SCSI host adaptor installed in your PC.

SCSI host adaptor	SCSI cable (not supplied)
Adaptec AHA-154X/151X series	Half pitch 50-pin ↔ Full pitch 50-pin
Future Domain TMC-850	Half pitch 50-pin ↔ D-sub 25-pin

Installing Software

A When using Macintosh systems

- 1** Insert the "MD DATA Installation Software for Macintosh" disk into the floppy drive, and place "MD Driver" and "MD File System" in the system folder by dragging them.

For more information, refer to "READ. ME" file in the floppy disk.

- 2** Re-start the system.

Note

When using the supplied MD DATA for the first time, format it in the same way as a floppy disk.

B When using portable PC with PCMCIA Type II or Type III slot

- 1** Turn off your computer system power.
- 2** Insert the SCSI card (supplied with Sony RMO-K600(E)) into the PCMCIA slot.
- 3** Start the system by turning the power of the computer on.
- 4** Install the ASPI Manager (supplied with the RMO-K600(E) or equivalent) correctly according to its operating instructions.
- 5** Insert the "MD DATA Installation Software for DOS/Windows" disk into the 3.5-inch floppy drive of the computer.
- 6** Double click "File Manager" in the "MAIN" window, select drive A and run SETUP. EXE.
If you are on the DOS prompt, type "A: SETUP" (or "B: SETUP" depending on your system) and press the Enter key.
- 7** Follow the instructions on the screen.

For details on installation, see "READ. ME" file in the floppy disk.

Installing Software (Continued)

C When using desk-top PC

- 1** Install the driver software according to its operating instructions supplied with the SCSI host adaptor.
- 2** Re-start the system by turning the power of the computer on.
- 3** Insert the "MD DATA Installation Software for DOS/Windows" disk into the 3.5-inch floppy drive of the computer.
- 4** Double click "File Manager" in the "MAIN" window, select drive A and run SETUP. EXE.
If you are on the DOS prompt, type "A: SETUP" (or "B: SETUP" depending on your system) and press the Enter key.
- 5** Follow the instructions on the screen.
For details on installation, see "READ. ME" file in the floppy disk.

To confirm the installation

You can confirm the software is installed correctly using the supplied MD DATA. Before using, format the MD DATA with the "MDformat" utility (see pages 19 and 22).

- 1** Set the POWER/Mode select switch to DATA.
- 2** Start the computer.
- 3** Insert the supplied MD DATA into the unit.
- 4** Run the "MDfsc" utility (see page 23) and make sure that "OK" appears on the monitor screen.

Now the preparation of the MD DATA drive is completed.

Recording/Reading Data

Formatting the MD DATA

Use the recordable MD DATA (2048 bytes/sector, 140 Mbytes formatted) with the MDH-10 for recording data.

Format the supplied MD DATA or a commercially available MD DATA before using it for the first time.

For DOS, "MDformat" utility can be used. (See page 22.)

For the supplied MD DATA, "Quick Format" is satisfactory.

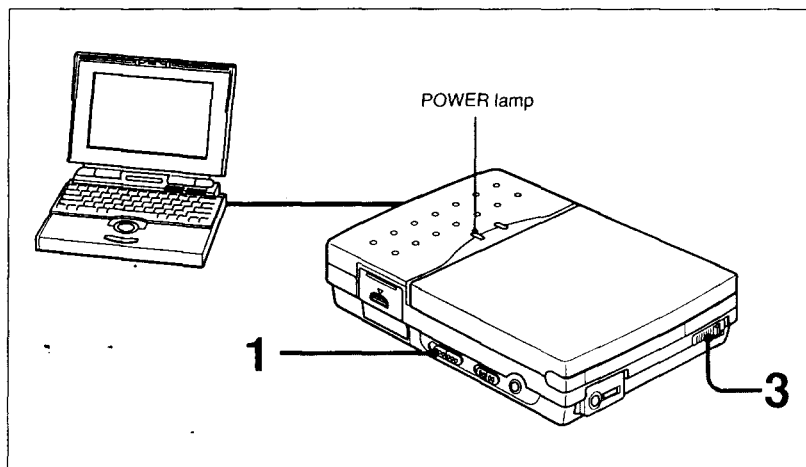

Recording/Reading
Data

1 Set the POWER/Mode select switch to DATA.

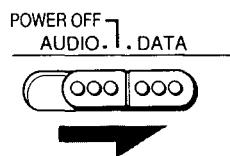

The POWER lamp lights in green.

2 Start the computer.

Refer to the operating instructions of the computer for starting.

(continued)

Recording/Reading Data (Continued)

3 Insert the recordable MD DATA.

① Slide OPEN to the right to open the lid.

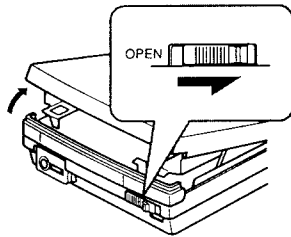

② Insert the MD DATA fully in the direction of the arrow.

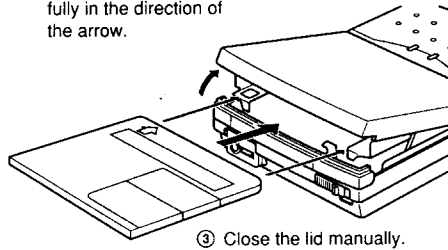

③ Close the lid manually.

4 Format the MD DATA

Recording/reading data



- 1 Set the POWER/Mode select switch to DATA.
- 2 Start the computer.
- 3 Insert the recordable MD DATA.
- 4 Operating the computer, record data or read data on the disk.

Note

Writing data should be done in a place free from vibration and impact.

About the BUSY lamp

The BUSY lamp on the unit lights as follows:

 green	while reading from or writing to the disc, etc.
 orange	while the buffer memory of the unit retains data to be recorded on the disc.

Notes

- When the BUSY lamp is on (green or orange), the disc cannot be removed.
- When the BUSY lamp is on, do not disconnect the AC power adaptor from the wall outlet.

To protect the recorded data from accidental erasure

Slide the safety tab so that a hole opens. The recorded data is protected and new data cannot be recorded. Close the hole by sliding the tab back when re-recording.

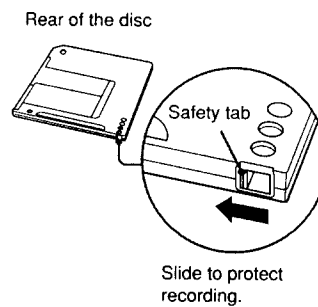

MD DATA Utilities (available only for DOS)

Like CD-ROMS, MD DATA has its own file system (MDFS, an abbreviation for MD DATA File System).

MDFS allows MD DATA to be interchanged between many different computers and consumer products. Since MDFS differs from the file system included with DOS, the utility programs that are provided with DOS cannot be used with MD DATA.

The following programs are included on the 3.5-inch floppy disk in the package labeled "MD DATA Installation Software for DOS/Windows." All the utility programs can be used on both Windows and DOS. If you start Windows "File Manager", you can find "MDtool" menu.

Detailed information about supported utilities are described in "READ.ME" file.

MDformat

Initializes MD DATA. The recordable MD DATA needs to be formatted at first.

MDformat destroys any data previously written to the disc. Use it as you would use the DOS format utility.

SYNTAX:

`mdformat [drive:][-q | s][-v:label -o -?]`

PARAMETERS:

drive:

Specifies the drive containing the disc that you wish to format.

SWITCHES:

- q initializes the disc with "Quick Format" ("Quick Format" is explained below), default
- s initializes the disc with "Safe Format" ("Safe Format" is explained below)
- v labels the volume, 31 characters max.
- o initializes the disc without any confirmation
- ? help

There are two types of formatting:

Quick Format

This type of formatting initializes the disc quickly. It installs MDFS on the disc, but it does not include Write/Read test of the file storage area on the disc. Therefore, you may have a little risk of error correction capability.

Below is an example showing initialization of the disc in drive E and labeling the disc with the volume name "MDDATA."

```
mdformat e: -qv:MDDATA
```

Quick formatting requires about 1 minute for completion.

Safe Format

This type of formatting initializes and certifies every sector of the disc for the absence of fatal defects. This type of formatting assures reliable storage and retrieval of files.

Below is an example showing initialization of the disc in drive E and labeling it with the volume name "MDDATA."

```
mdformat e: -sv:MDDATA
```

Safe formatting requires about 35 minutes for completion.

MDfck

Checks whether a disc conforms to the MD DATA standard. If the disc has been formatted with other drives, use MDfck to check the validity of the format. Use it as you would the DOS chkdsk command.

SYNTAX:

```
mdfck [drive:] [-?]
```

PARAMETERS

drive:

Specifies the drive containing the disc to be checked.

SWITCHES:

-? help

MD DATA Utilities (Continued)

MDplay

Plays an audio MiniDisc under computer control. If you open Windows "Program Manager", you can find "MD DATA" group. Open it and double click "MDplay" icon to start an audio MD playback.

SYNTAX:

mdplay [-?] [drive:] [play [song-number] | pause | stop | prev | next]

PARAMETERS

drive:

Specifies the drive containing the MiniDisc to be played.

play [song-number]

Start audio. If a [song-number] is provided, audio is started at that song number. If [song-number] is not provided, audio is started at the first song on the disc unless audio has been previously paused. If playback is paused, playback resumes from the point where it was paused.

pause

Pauses playback. Playback may be resumed using the play parameter.

stop

Stops playback.

prev

Begins playback at the start of the track preceding the one currently being played.

next

Begins playback at the start of the track following the one currently being played.

SWITCHES:

-? help

Listening to an Audio MD

— Using the Unit as a Portable MiniDisc Player

Connection

Connect the AC power adaptor and the headphones with a remote controller to the unit.

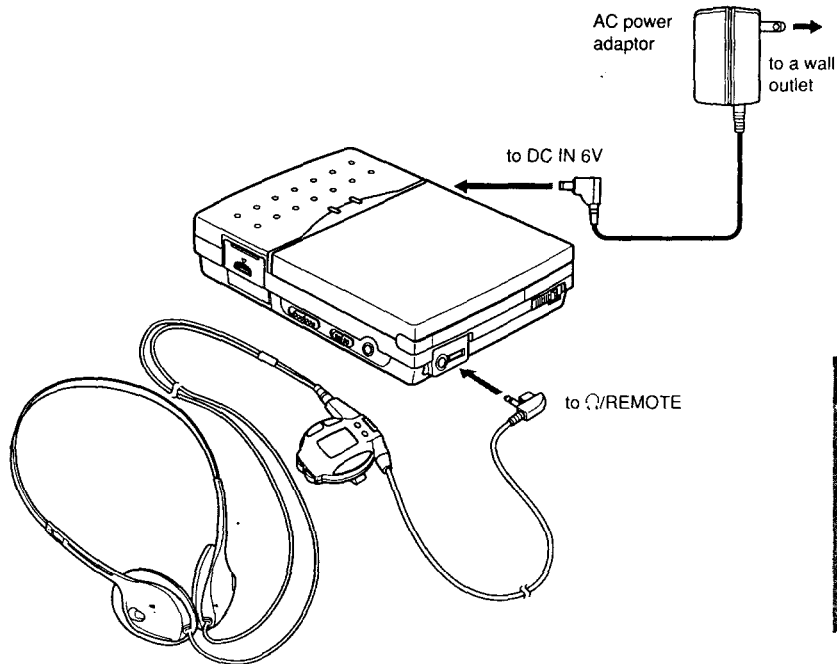

Listening to an
Audio MD

Note

About the AC power adaptor

Use the supplied AC power adaptor only.
Do not use any other AC power adaptor.

Polarity of the plug

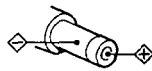

Power Sources

The MDH-10 can operate on AC, rechargeable battery, and dry battery power.

Using on the rechargeable battery

Before using the supplied rechargeable battery for the first time, you must charge it. The battery can be recharged about 300 times.

1 Connect the supplied AC power adaptor to a wall outlet.

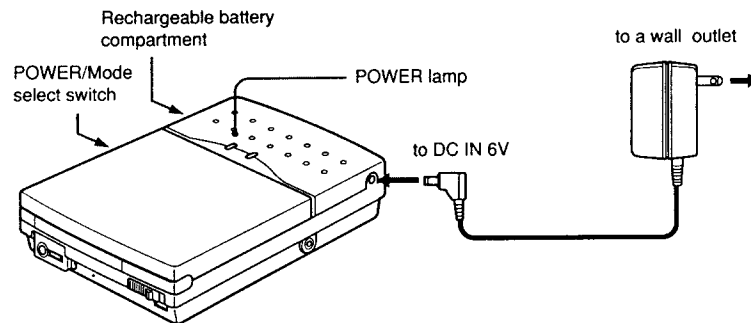



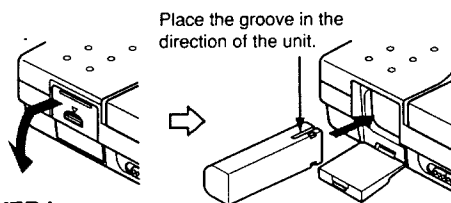





2 Open the battery compartment lid and insert the battery.



About the POWER lamp

The POWER lamp lights as follows:

POWER/Mode select switch	POWER lamp		
	Charging begins	While charging	Charging completed
DATA	 green	→  orange	→  green
AUDIO	 green	→  orange	→  green
POWER OFF	 off	→  orange	→  off

Charging a completely discharged battery takes about 3 hours for 80% charging, or about 5 hours for 100% charging.

3 Disconnect the AC power adaptor.

As long as the unit is connected to the AC power, the power will be supplied from AC.

Notes

On recharging

- Be sure to use the supplied AC power adaptor.
- When you use the battery for the first time or after a long period of disuse, the battery life may be diminished. In this case, charge and discharge the battery several times. The battery life will be restored.
- Set the POWER/Mode select switch to OFF for full recharging.

On the POWER lamp

The POWER lamp lights in green even during charging:

- while executing a SCSI command when the POWER/Mode select switch is set to DATA.
- while operating the unit with the remote controller when the POWER/Mode select switch is set to AUDIO.

On the rechargeable battery

- To charge the battery, use only the MDH-10.
- Do not disassemble or short-circuit the battery, or throw it into fire.
- Do not expose the battery to moisture.
- Do not drop the battery or subject it to mechanical shock.

Checking the charging condition

Connect the remote controller to the MDH-10. While charging, the battery indication appears in the display as follows:



While charging -----> Charging completed

Battery charging tips

- You can charge the battery at any time. The rechargeable battery does not need discharging before recharging. You can recharge a half-charged battery. However, the rechargeable battery discharges little by little even while it is not in use. We recommend that you charge it before every use.
- Keep a few spare batteries. To avoid power shortage, prepare a few extra rechargeable batteries, model LIP-12 (not supplied).
- To check the charging condition of the battery, use the charging check switch on the battery. Set the switch to the "no mark" position when charging is completed. Set the switch to the "red mark" position when the battery is used up.
- To ensure the maximum number of chargings and dischargings, we recommend storing the battery in a cool place and charging it under temperatures ranging from 50°F to 86°F (10°C to 30°C). When the battery is not to be used for a long time, be sure to remove it from the MDH-10.

Listening to an Audio MD

Power Sources (Continued)

Using on dry batteries

1 Mount the battery case.

Insert the DC plug into the DC IN 6V jack so that the projection on the battery case fits to the groove on the MD DATA drive, fit the hook of the battery case to the groove at the front of the MDH-10, and attach the case with the screw on the bottom.

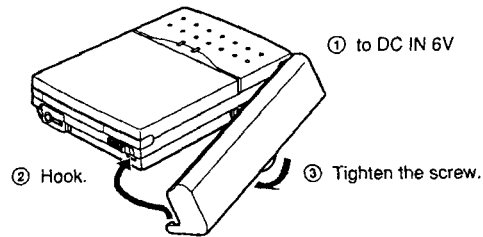

2 Install three size AA (R6) alkaline batteries (not supplied) in the order ① to ③.

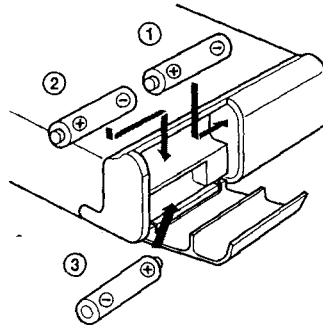

Notes

On dry batteries

Incorrect use of dry batteries may cause leaking or explosion. Please observe the following precautions:

- Insert the batteries with correct polarities (+ and -).
- Do not use new and old batteries or different types of batteries together.
- Do not charge dry batteries.
- Remove the batteries when they are not to be used for a long period of time.

If batteries leak, wipe off the liquid on the battery case and install new batteries.

Checking the battery condition

You can check the battery condition with the battery indication on the remote controller.

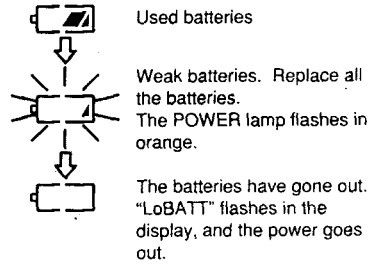

Battery life during playback*

Batteries in use	Playback
Rechargeable battery**	Approx. 2 hours
Size AA (R6) alkaline batteries	Approx. 2 hours
Rechargeable and size AA (R6) batteries used together	Approx. 4.5 hours

* The battery life may be diminished due to operating condition and the temperature of the location.

** If the rechargeable battery capacity becomes half the normal life, replace it with a new one.

Listening to an
Audio MD

Playing an Audio MD

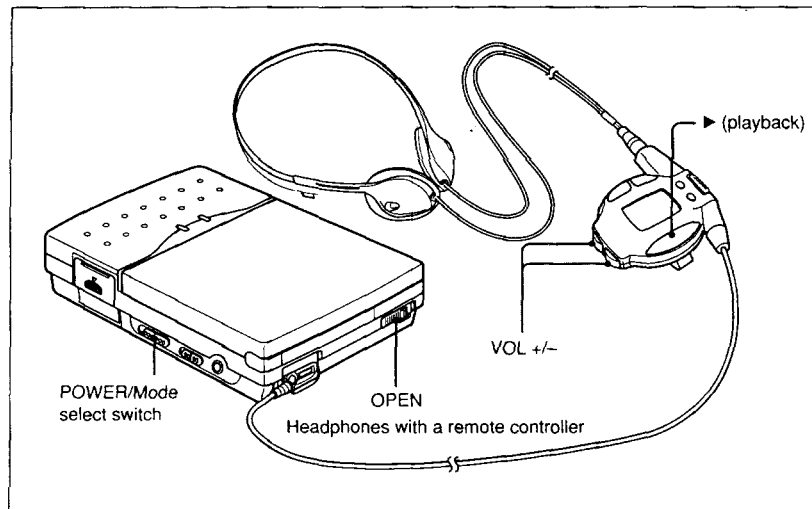

- 1 Set the POWER/Mode select switch to "AUDIO."

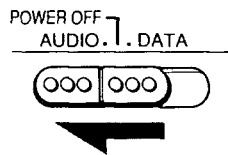

- 2 Insert a commercially available prerecorded MD or a recordable MD which has been previously recorded.

- ① Slide OPEN to the right to open the lid.

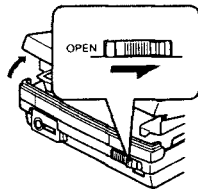

- ② Insert the MD fully in the direction of the arrow.

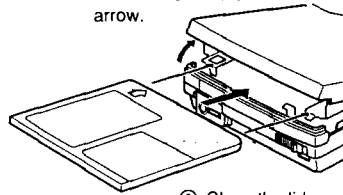

- ③ Close the lid manually.

When a disc is inserted, the following indication appears in the display window of the remote controller.

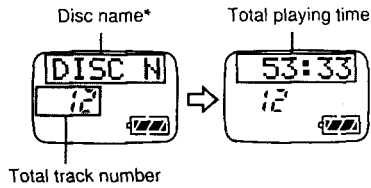

* No indication appears with MDs that have not been electronically labeled.

3 Press the ► button on the remote controller.

The MDH-10 will start playback.

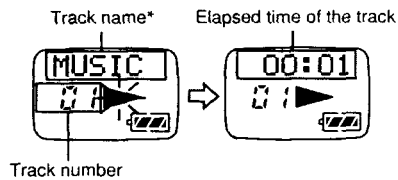

* No indication appears with MDs that have not been electronically labeled.

4 Adjust the volume by pressing the + side or the - side of VOL +/- button on the remote controller.

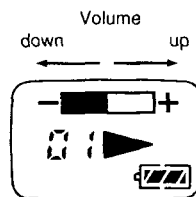

Note

If you cannot increase the volume, the AVLS switch on the unit is set to ON (the volume indication flashes). In this case, set the switch to OFF. (See "Useful tips on playing an MD" on page 35.)

Listening to an Audio MD

Playing an Audio MD (Continued)

To	Press	Beep on the headphones (when operating on the remote controller)
pause/release pause	 (continuous short beep)
stop	■	- (one long beep)
rewind while listening	Keep pressing ◀◀	(none)
fast forward while listening	Keep pressing ▶▶	(none)
quickly rewind without listening	(pause) and keep pressing ◀◀	(none)
quickly fast forward without listening	(pause) and keep pressing ▶▶	(none)
find the beginning of the current track	Press ◀◀ once shortly	... (three short beeps)
find the beginning of the next track	Press ▶▶ once shortly	.. (two short beeps)
eject the MD	after ■ (stop), slide OPEN to the right and open the lid	(none)

Playing specific tracks

Using the remote controller, you can find a specific track before playing an MD and start playing from the track.

- 1 Press the ►► or ◀◀ button on the remote controller to find a specific track.

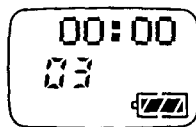

- 2 Press the ► button to start playing.

Notes

Sound skipping

- The MDH-10 has a shock resistant memory for audio playback. However, if it is subject to continuous vibration, the sound may skip or mute while playing an MD. In this case, use the unit in a stable place.
- Tracks that are very short, such as a brief narration or introduction, may cause the sound to skip while being played.

You can resume playing from the point the MD stopped (Resume function).

If you stop playing partway and leave the MD in the unit, the unit will resume playing from the point where the MD stopped and retain the selected play mode in memory.

Once you open the lid or set the POWER/ Mode select switch to POWER OFF, the memory will be erased and the unit will start playing from the beginning of the first track.

Listening to an
Audio MD

Playing the Tracks Repeatedly (Repeated Playback)

You can play tracks repeatedly in three ways — all repeat, single repeat, and shuffle repeat.

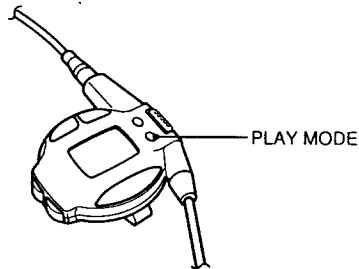

Press the **PLAY MODE** button on the remote controller while the MD is playing.

Each time you press the **PLAY MODE** button, the play mode indication changes as follows:

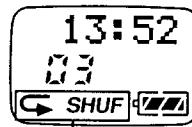

Play mode indication

Play mode	To play	Indication
Normal play ↓	all the tracks once	(none)
All repeat ↓	all the tracks repeatedly	↻
Single repeat ↓	a single track repeatedly	↻ 1
Shuffle repeat	all the tracks in random order repeatedly	↻ SHUF

Useful Tips on Playing an MD

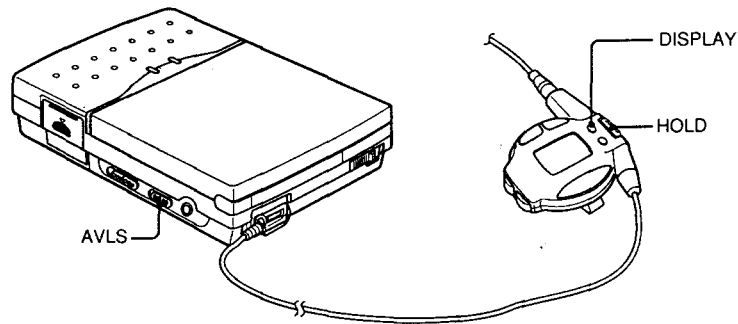

Locking the controls (HOLD function)

Slide the **HOLD** switch in the direction of the arrow.
Operation buttons on the remote controller are locked.

Adjusting the sound to an appropriate level (AVLS function)

Set the **AVLS** switch on the unit to **ON**.
This function allows you to limit the maximum volume without degrading the sound quality.

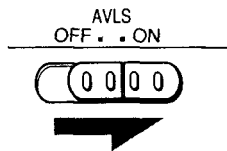

Listening to an
Audio MD

Useful Tips on Playing an MD (Continued)

Displaying disc and track names and elapsed time during playback

Press the **DISPLAY** button during playback.

You can display information on the MD which has been electronically labeled. Each time the **DISPLAY** button is pressed, the indication changes as follows:

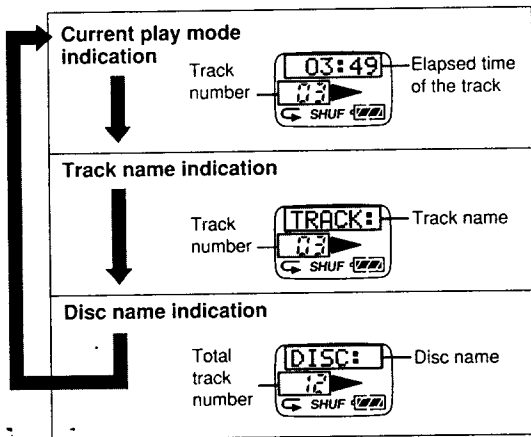

Notes

- No character information appears with MDs that have not been electronically labeled.
- The MDH-10 does not label or copy any character information such as disc names and track names.

Using the unit in an audio system

Connect the **RK-G129** cable or equivalent stereo miniplug to two phono plug cable (not supplied) to the **LINE OUT** jack.

The output signal is analog.

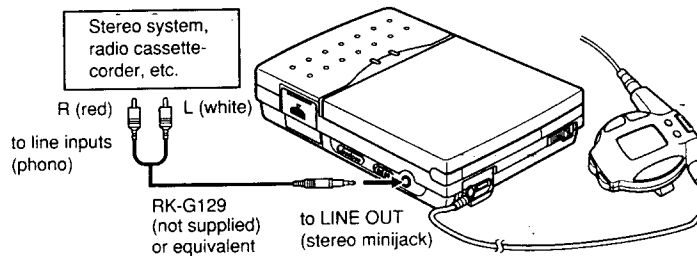

Others

Identification of Parts

See pages in () for more details.

MDH-10

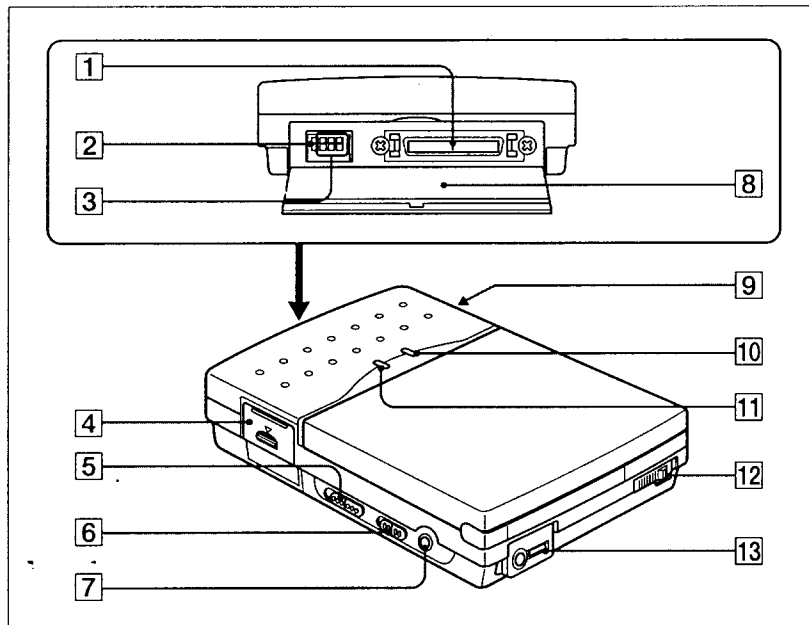

- 1 SCSI connector (14, 15, 16)
- 2 Terminator switch (12)
- 3 SCSI ID switches (13)
- 4 Rechargeable battery compartment (26)
- 5 POWER/Mode select switch (19, 30)
- 6 AVLS switch (35)
- 7 LINE OUT jack (36)

- 8 Connector cover (12)
- 9 DC IN 6V jack (14, 15, 16, 25, 26)
- 10 BUSY lamp (21)
- 11 POWER lamp (20, 26)
- 12 OPEN (disc eject) button (19, 30)
- 13 /REMOTE (headphones, remote controller) jack (25, 30)

Identification of Parts (Continued)

Remote controller

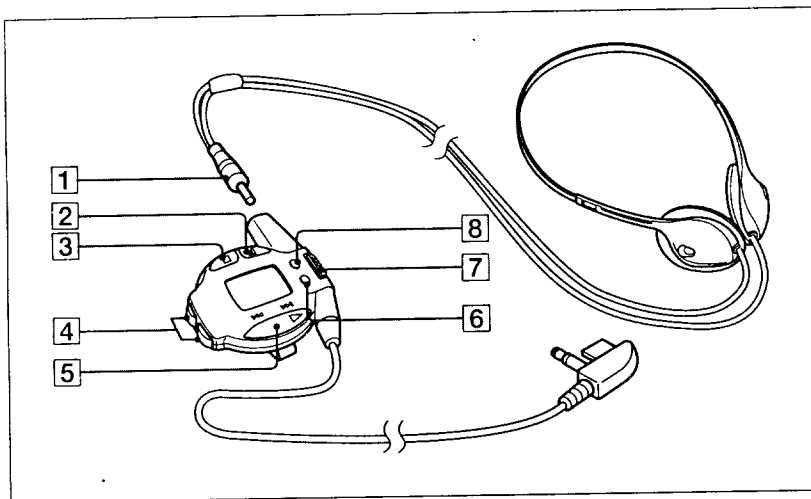

- | | |
|--|-------------------------|
| 1 Microplug (8) | 6 PLAY MODE button (34) |
| 2 (pause) button (32) | 7 HOLD switch (35) |
| 3 ■ (stop) button (32) | 8 DISPLAY button (36) |
| 4 VOL+/- (volume control) button (31) | |
| 5 ▶ (play)/ ◀◀/▶▶ (search, rewind/fast forward) button (31, 32, 33) | |

Precautions

On safety

- Since the laser beam used in the MDH-10 is harmful to the eyes, do not attempt to disassemble the casing. Refer servicing to qualified personnel only.
- Do not put any foreign objects in the DC IN 6V jack.

On power sources

- Use the house current, rechargeable battery pack (supplied), or three size AA (R6) batteries.
- For use on house current: Use the AC power adaptor supplied with this unit. Do not use any other AC power adaptor since it may cause the unit to malfunction.
- The unit is not disconnected from the AC power source (mains) as long as it is connected to the wall outlet, even if the unit itself has been turned off.
- If you are not going to use the unit for a long time, be sure to disconnect the power supply (AC power adaptor, rechargeable battery pack, or size AA (R6) batteries). To remove the AC power adaptor from the wall outlet, grasp the adaptor plug itself; never pull the cord.

On heat build-up

Heat may build up in the unit if it is used for an extended period of time. In this event, allow the unit to cool down.

On installation

- Never use the unit where it will be subject to extreme of light, temperature, moisture or vibration.
- Never wrap the unit in anything when it is being used with the AC power adaptor. Heat build-up in the unit may cause malfunction or injury.

On the headphones

• Road safety

Do not use headphones while driving, cycling, or operating any motorized vehicle. It may create a traffic hazard and is illegal in many areas. It can also be potentially dangerous to play your unit at high volume while walking, especially at pedestrian crossing. You should exercise extreme caution or discontinue use in potentially hazardous situations.

• Preventing hearing damage

Avoid using headphones at high volume. Hearing experts advise against continuous, loud and extended play. If you experience a ringing in your ears, reduce the volume or discontinue use. Use the AVLS function to avoid excessive pressure to your ears.

• Caring for others

Keep the volume at a moderate level. This will allow you to hear outside sounds and to be considerate of the people around you.

Precautions (Continued)

On the MD DATA/MiniDisc cartridge

- Do not break open the shutter.
- Do not place the cartridge where it will be subject to light, temperature, moisture or dust.
- Do not touch the surface of the disc inside of the cartridge.

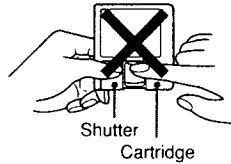

On cleaning

- Clean the casing with a soft cloth slightly moistened with water or a mild detergent solution. Do not use any type of abrasive pad, scouring powder or solvent such as alcohol or benzene as it may mar the finish of the casing.
- Wipe the disc cartridge with a dry cloth to remove dirt.
- Dust on the lens may prevent the unit from operating properly. Be sure to close the disc compartment lid after inserting and ejecting a disc.

If you have any questions or problems concerning your unit, please consult your nearest Sony dealer.

Troubleshooting

If you experience any of the following difficulties while using the unit, use this troubleshooting guide to help you remedy the problem.

When connected to a computer

Symptom	Cause	Solution
The unit does not operate or operates poorly.	SCSI cable is disconnected.	Connect the SCSI cable correctly. (pages 14 to 16)
	The same SCSI ID is set for two devices.	Set the SCSI ID switches correctly. (page 13)
	Terminator is not set correctly.	Set the terminator switch correctly. (page 12)
	AC power adaptor is not connected properly.	Plug in the adaptor firmly. (pages 14 to 16)
	The power source is not connected. Or the POWER/Mode select switch is set to AUDIO or POWER OFF.	Set the POWER/Mode select switch to DATA. (page 19)
	MD DATA is not inserted.	Insert an MD DATA.
	MD is inserted instead of an MD DATA.	Insert an MD DATA.
	While operating, the unit received a mechanical shock, too much static, or abnormal power voltage caused by lightning, etc.	Restart the operation as follows: 1 Remove all the power sources. 2 Leave the unit disconnected for about 30 seconds. 3 Connect the power source.
The computer does not recognize the drive.	Software is not properly installed.	Re-install the software. (page 18)
The unit does not record.	The safety tab of recordable MD DATA is set to disable recording.	Slide the safety tab on the recordable MD DATA to close the lid.
	Disc other than recordable MD DATA is inserted.	Insert a recordable MD DATA.



Troubleshooting (Continued)

Messages while installing the software for DOS

During installation of the software for DOS, a variety of messages are displayed when trouble occurs as described below:

Message	Cause	Solution
ERROR 1: unable to open device driver	The line DEVICE = drive: \[path] \MDMGR.SYS needs to be added to the CONFIG.SYS file.	Check that the drive is installed correctly.
No MD DATA devices found	The Power SCSI! software is not installed correctly when the Future Domain host adaptor is used.	Install the Power SCSI! software correctly.
Warning: Drive assigned from X	The drive letter specified in the /L: parameter of MDFSEX.EXE has already been assigned to another device.	Check the drive letter. (Refer to "READ.ME" file for supported parameters for MDFSEX.EXE.)
Warning: X drive(s) not assigned!	No drive letter is available for assignment to the MD DATA drive, so one or more drives were not assigned.	Change the LASTDRIVE specification in CONFIG.SYS file.
Error: Unsupported DOS Version	The version of DOS on your system is not supported by the drive software.	Use the correct DOS Operating System. (Version 5.0 and up)
Error: Installation is not permitted	Other system software is preventing installation of the MD DATA File System Extensions.	Check AUTOEXEC.BAT file.
Error: Already installed	The MD DATA File System Extensions have already been installed. You cannot launch the MD DATA File System Extensions more than once.	Delete the duplicated line from AUTOEXEC.BAT file.
Error: No MD DATA drive is connected!	MDMGR could not find an MD DATA drive to manage.	Check the power and SCSI cable connections to the MD DATA drive.
Error: No MDMGR installed.	MDMGR is not correctly installed.	Check if MDMGR.EXE is in your CONFIG.SYS file.

What the SETUP program adds on your system

The DOS AUTOEXEC. BAT File

The SETUP program adds the following line to your AUTOEXEC. BAT file:

```
[path]\MDMGR.EXE  
[path]\MDFSEX
```

The DOS CONFIG.SYS File

The SETUP program adds the following lines to your CONFIG.SYS file:

```
DEVICE=[path]\MDMGR.SYS
```

Common troubles while installing the software for DOS

Here's some tips in case your system doesn't work correctly when restarting the PC.

Check order of device drivers in CONFIG. SYS

The order of numerous device drivers in the CONFIG. SYS file sometimes affects the system operation. To analyze this kind of problem, the simplest way is to disable other device drivers by typing "REM" at the beginning of each line. Find out which device driver has a conflict with the MDMGR. SYS by enabling them one by one.

Memory size

Most of the device drivers occupy a certain size of memory area. If the device drivers in your system already occupy a large portion of memory area and have little room for MDFSEX. EXE and MDMGR. SYS, the system may not work. You have to delete drivers which you feel least important until enough memory area is secured for MDFSEX. EXE and MDMGR. SYS.

Note: If the system hangs during boot, boot the system from the system floppy disk and perform the analysis described above.

Troubleshooting (Continued)

When listening to an MD

Symptom	Cause	Solution
The unit does not operate.	No power is supplied, or the POWER/Mode select switch is set to DATA or POWER OFF. When the switch is set to DATA, you cannot operate from the remote controller.	Set the POWER/Mode select switch to AUDIO. (page 30)
	No MD is inserted. ("NoDISC" indication appears.)	Insert an MD.
	HOLD function is in use.	Release HOLD by sliding the HOLD switch on the remote controller in the opposite direction of the arrow.
	Moisture has condensed inside the unit.	Remove the disc and leave the unit for a few hours.
	AC power adaptor is not connected properly.	Connect the AC power adaptor properly. (page 25)
	Rechargeable battery or dry batteries are discharged. (☐ or "LoBATT" indication appears, and POWER lamp flashes in orange.)	Charge the rechargeable battery or replace all three size AA (R6) batteries. (pages 26 and 28)
	Rechargeable battery or dry batteries are completely discharged.	Charge the rechargeable battery or replace all three size AA (R6) batteries. (pages 26 and 28)
	Batteries are not correctly inserted.	Insert the batteries with correct polarities. (page 28)
	A blank MD is inserted. ("BLANK" indication appears.)	Replace the disc with a prerecorded or previously recorded MD.
	MD is damaged. ("ERROR" indication appears.)	Re-insert the disc. If "ERROR" still appears, replace it with another disc.
	MD DATA is inserted. ("DATA" and "DISC" are indicated alternately.)	Insert an MD.
	While operating, the unit received a mechanical shock, too much static, or abnormal power voltage caused by lightning, etc.	Restart the operation as follows: 1 Remove all the power sources. 2 Leave the unit disconnected for about 30 seconds. 3 Connect the power source.
Does not play back normally.	Repeat playback is specified.	Press the PLAY MODE-button. Start playing after  (repeat) indication disappears.

Symptom	Cause	Solution
An MD is not played from the first track.	Disc playing stopped before it came to the last track.	Press the ◀◀ button repeatedly, or open and close the lid once to go back to the beginning of the MD, and restart playing after checking the track number in the display.
Sound has a lot of static.	Strong magnetism from a television or such device is interfering with operation.	Move the unit away from the source of strong magnetism.
Does not charge.	AC power adaptor is not connected properly.	Connect correctly. (page 26)
No sound comes through the headphones.	Headphones with a remote controller are not connected properly.	Connect the headphones to  / REMOTE properly. (page 25)
	Volume is set too low.	Adjust the volume with VOL +/- button. (page 31) Set the AVLS switch to OFF. (page 35)
	Microplug of the headphones is not connected to the remote controller properly.	Connect the microplug of the headphones to the remote controller properly. (page 8)

Error messages when listening to an MD

Error message	Meaning	Solution
BLANK	A blank MD is inserted and played.	Replace the MD with a prerecorded or previously recorded MD.
ERROR	A damaged MD is inserted.	Remove and insert the MD again. If ERROR still appears, replace the disc with another.
LoBATT	Batteries are discharged.	Charge the rechargeable battery or insert new batteries. (pages 26 and 28)
NoDISC	No MD is inserted.	Insert an MD.
DATA DISC	MD DATA is inserted.	Insert an MD.

Specifications

Drive

Data section

Type Portable MD DATA drive
 Host interface SCSI-2
 Transfer speed 150 kBPS
 Average seek time 500 msec or less.
 Error rate 10^{-12} or less
 Linear velocity 1.2 m/sec. to 1.4 m/sec.
 (CLV)
 Writing method Magnetic field modulation
 optical system
 Reading method Non-contact optical reading
 (semi-conductor laser is used)
 Laser diode properties
 Material: GaAlAs
 Wavelength: $\lambda = 780$ nm
 Power output: 35 mW max.
 N.A.: 0.45
 Modulation system EFM
 Error correction Advanced Cross Interleave
 Reed Solomon Code
 (ACIRC)

Audio section

Sampling frequency 44.1kHz
 Coding Adaptive TTransform
 Acoustic Coding (ATRAC)
 Number of channels 2 stereo channels
 Frequency response 20 to 20,000Hz \pm 1dB
 Wow and flutter Below measurable limit

Output	Headphones	Line output
Jack type	Stereo minijack	Stereo minijack
Rated output level	-	194mV
Maximum output level	5mW+5mW	-
Load impedance	16 ohms	10k ohms

Service environment

Orientation Horizontal or vertical
 Temperature 5°C to 45°C (41°F to 113°F)

General

Power requirements

- LIP-12 rechargeable battery (Lithium-ion battery pack, supplied)
- Three size AA (R6) alkaline batteries (not supplied)
- Sony AC power adaptor (supplied) at the DC IN 6V jack, 120 V AC, 60Hz

Battery operation time

120 minutes of consecutive playback with fully charged LIP-12

Dimensions Approx. 86 × 30 × 131 mm
(3 1/2 × 1 3/16 × 5 1/4 inches)
not including projections

Mass Approx. 340 g (12 oz) incl. rechargeable battery

Optional accessories

Lithium-ion battery pack

- LIP-12

MD DATA

- MMD-140 (2048 bytes/sector, 140 Mbytes)

PCMCIA Interface Kit

- RMO-K600 (E)

Your dealer may not handle some of the above listed accessories. Please ask the dealer for detailed information about the accessories in your country.

Design and specifications are subject to change without notice.

Portable MD DATA Drive **MDH-10**



Sony Corporation Printed in Japan